

深圳市天成照明有限公司

SPECIFICATIONS

产品规格书

客户名称		产品名称	5050「晶元」系列
客户代码		产品规格	TC5050WXD22-3CESR3



客 户 确 认			
制定	审核	核准	
黄奕源		金国奇	
版本号 (Version No) : 1.0			



地址：深圳市宝安区松岗街道东方大道 33 号

电话：0755-29573599 29573979 传真：0755-29573533

网址：<http://www.tczmled.com> 邮编：518106



◆ Mechanical Specification (产品特性)

- **5.00mm*5.00mm*1.6mm SMD LED**
(表面贴片器件尺寸为5.00mm*5.00mm*, 1.6mm)
- **The materials of the LED dice is InGaN**
(发光二极管所用芯片材料为氮化镓)
- **Suitable for all SMT assembly and welding process**
(适用于的所有的SMT装配和焊接工艺)
- **moisture resistant grade: Level 2a**
(防潮等级Level 2a)



◆ Package Outline (封装尺寸)

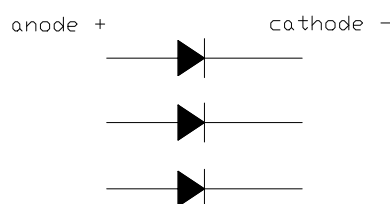
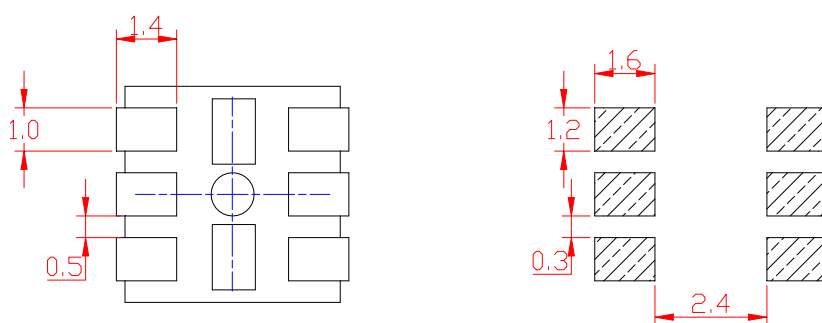
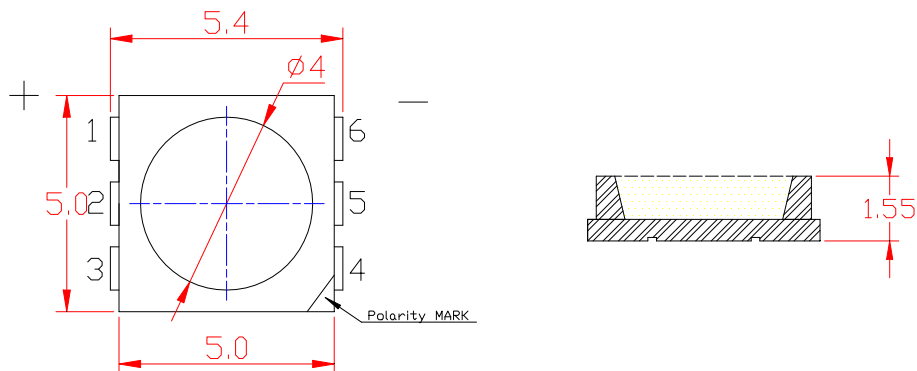

NOTES:

1. All dimensions are in millimeters (所有标注尺寸的单位均为毫米)
2. Tolerances are $\pm 0.2\text{mm}$ unless otherwise noted (除了特别注明, 所有标注尺寸的公差均为 $\pm 0.2\text{mm}$)

◆ Absolute maximum ratings at Ta=25°C (绝对最大额定值)

Parameters (参数)	Symbol (符号)	Value (值)	Unit(单位)
Power Dissipation (功耗)	Pd	200	mW
Forward Current (正向电流)	IF	60	mA
Pulse Forward Current (脉冲电流)	IFP	100	mA
Reverse Voltage (反向电压)	VR	5	V
Electrostatic Discharge (静电)	ESD	2000(HBM)	V
Operating Temperature (操作温度)	Topr	-40 ~ +85 °C	°C
Storage Temperature (保存温度)	Tstg	-40 ~ +100 °C	°C

◆ Electro-optical characteristics at Ta=25°C (电光特性)

Item (项目)	Symbol (符号)	Mix (最小)	Typ (平均)	Max (最大)	Unit (单位)	Conditions (测试条件)
Forward voltage (正向电压)	VF	2.8		3.2	V	IF=60mA
Reverse current (反向电流)	IR	--	--	5	μA	VR = 5V
Chromaticity (色温)	TC	2600	--	2800	K	IF=60mA
		2800	--	3200		
		3800	--	4200		
		4800	--	5200		
		6000	--	6500		
Color Rendering (显色指数)	Ra	80	--	85	/	IF=60mA
Viewing angle (发光角度)	2θ 1/2		120		Deg	IF=60mA
Luminous intensity (发光强度)	Φ	22	--	24	Lm	IF=60mA
Color tolerance (色容差)	SDCM	--		4		IF=60mA

NOTE: (Tolerance: $I_v \pm 10\%$, $\lambda_d \pm 2nm$, $V_f \pm 0.05V$) (公差: $I_v \pm 10\%$, $\lambda_d \pm 2nm$, $V_f \pm 0.05V$)

◆ Typical optical characteristics curves (典型光学特性曲线)

Spectral Distribution

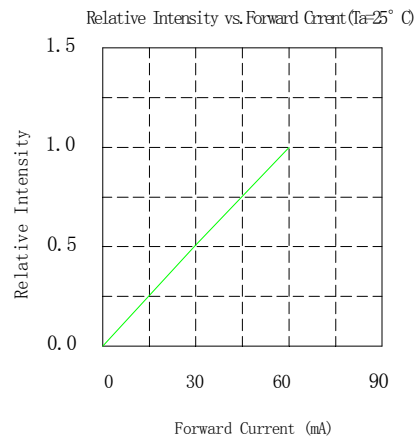
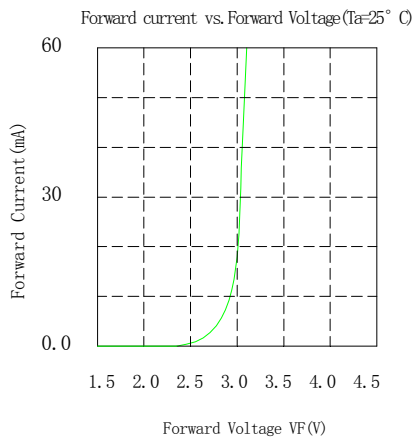
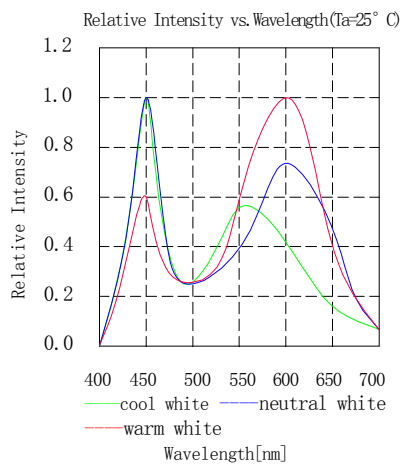

Derating

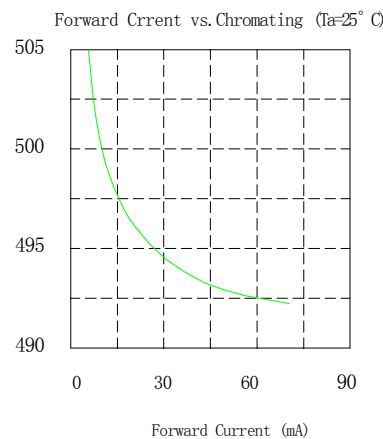
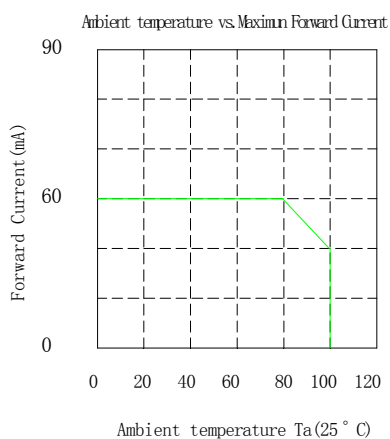
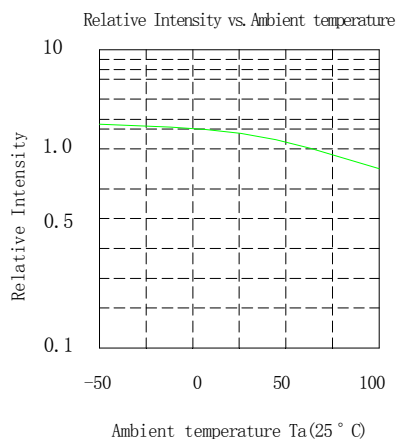
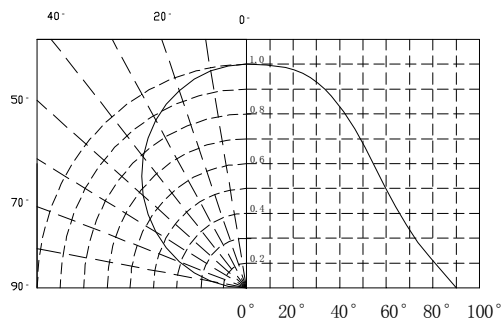
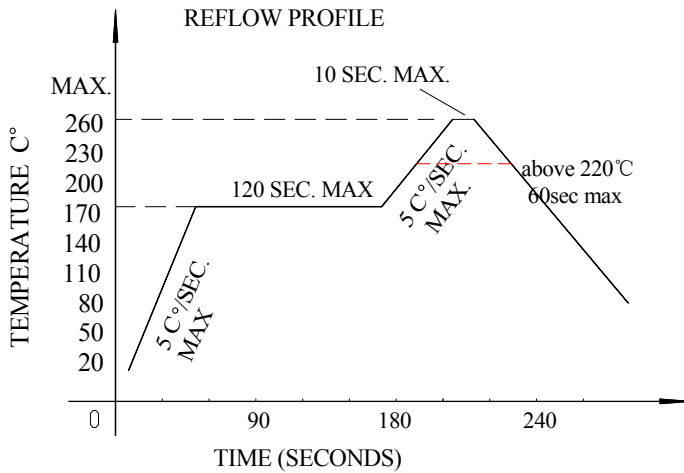

Diagram characteristics of radiation



◆ Reflow profile (焊接说明)

■ SMD Reflow Soldering Instructions (回流焊简介)



1. Reflow soldering should not be done more than two times
回流焊次数不应超过 2 次
2. When soldering, do not put stress on the LEDs during heating
焊接时，在加热过程中不能有应力作用于 LED 灯珠

■ Soldering iron (烙铁)

1. When hand soldering, keep the temperature of the iron under 300°C, and at that temperature keep the time under 3 sec.
手工焊接时，烙铁温度控制在 300°C 以下，且时间不可超过 3 秒
2. The hand soldering should be done only a time
手工焊接只可焊接一次

■ Rework (返工)

1. Customer must finish rework within 5 sec under 260°C
温度保持在 260°C 以下，5 秒内完成返工作业
2. The head of iron can not touch the LEDs
烙铁不能碰触到 LED 灯珠
3. Twin-head type is preferred.
双头形烙铁为最佳

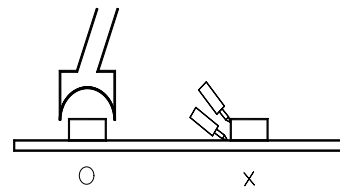

■ CAUTIONS (注意事项)

The encapsulated material of the LEDs is silicone. Therefore the LEDs have a soft surface on the top of package. The pressure to the top surface will be influence to the reliability of the LEDs. Precautions should be taken to avoid the strong pressure on the encapsulated part. So when using the picking up nozzle, the pressure on the silicone resin should be proper.

封装的 LED 为硅材料。该 LED 具有软表面的封装顶部。顶部表面的压力会影响 LED 的可靠性。应采取预防措施，以避免有过大的压力作用于在封装件上。因此，在选用吸嘴时，应适用于有机硅树脂的压力。

◆ Product comparison table (产品对照表)

Product model (产品型号)	Lot number (产品批号)	Chromaticity (色温)	Luminous intensity (分光强度)	Color Rendering (显色指数)	Color tolerance (色容差)
TC5050W6D22-3CESR3	AW604	6000-6500K	22-24LM	80	
TC5050W5D22-3CESR3	AW504	4800-5200K	22-24LM	80	≤4
TC5050W4D22-3CESR3	AW404	3800-4200K	22-24LM	80	≤4
TC5050W3D22-3CESR3	AW304	2800-3200K	22-24LM	80	≤4
TC5050W2D22-3CESR3	AW204	2600-2800K	22-24LM	80	≤4

◆ Reliability (可靠性)

TEST ITEMS AND RESULTS (测试项目和结果)

Test Items (测试项目)	Ref.Standard (参考标准)	Test Condition (测试条件)	Time (时间)	Quantity (数量)	Ac/Re (接收/拒收)
Reflow (回流焊)	JESD22-B106	Temp=260°C max T=10sec	3 times	0/22	0/1
Temperature Cycle (温度循环)	JESD22-A104	-20°C ± 5°C 30min ↑↓5min 120°C ± 5°C 30min	200 cycle	0/22	0/1
Thermal Shock (冷热冲击)	JESD22-A106	-40°C ± 5°C 15min ↑↓5sec 100°C ± 5°C 15min	200 cycle	0/22	0/1
High Temperature Storage (高温存储)	JESD22-A103	Temp=100°C ± 5°C	1000 hrs	0/22	0/1
Low Temperature Storage (低温存储)	JESD22-A119	Temp=-40°C ± 5°C	1000 hrs	0/22	0/1
Power temperature Cycling (点亮高低温循环)	JESD22-A105	On5min-40°C >5min ↑↓ ↑↓<5min Off5min100°C >5min	200 cycle	0/22	0/1
Life Test (老化测试)	JESD22-A108	T _a =25°C ± 5°C I _F =60mA	1000 hrs	0/22	0/1
High Temperature High Humidity Life Test (高温高湿)	JESD22-A101	85°C ± 5°C / 85%RH I _F =60mA	1000 hrs	0/22	0/1

◆ Packaging Specifications (包装规格)

● Feeding Direction (进料方向)

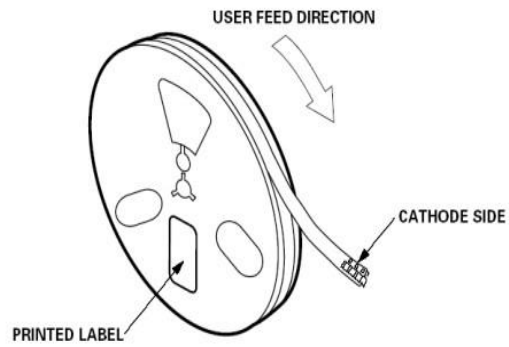

● Dimensions of Reel (Unit: mm) (卷轴尺寸 (单位: 毫米))

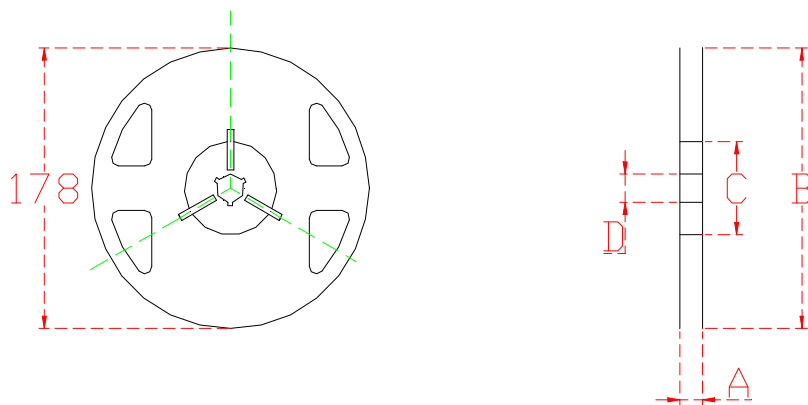

A	8.0±0.1mm
B	178±1mm
C	60±1mm
D	13.0±0.5mm

1、Packing Icon (包装图标)

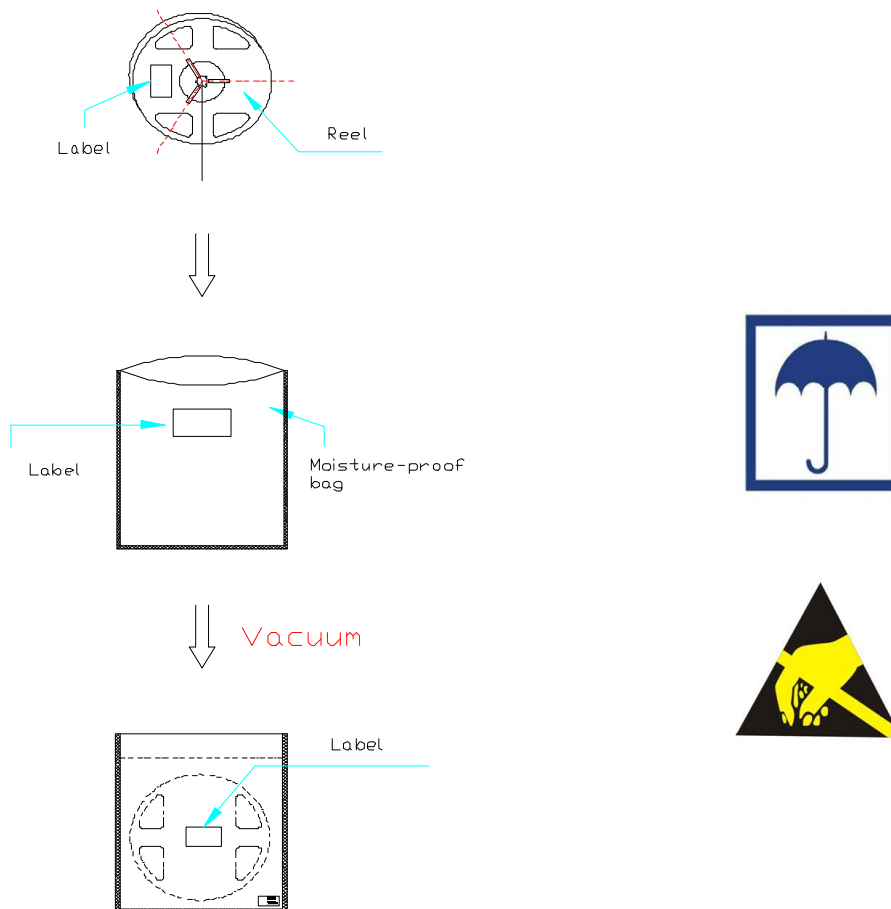

2、Label Icon (标签图标)

The label contains the following information:

深圳市天成照明有限公司

产品型号: PN:XXXXXXXXXXXX

产品编号: SN:XXXXX

产品色区: CIEXY:XX

产品数量: QTY:XXXXX

产品参数:

	Min	Max
VF(v)	XX	XX
IV(LM)	XX	XX
TC(k)	XX	XX

产品条形码: XXXXXXXXX

产品 BIN 号: X